

Temporary Stream, Wetland & Soft Soil Crossings



Minnesota Erosion Control Association



*Advancing Effective
Stormwater Management
and Erosion Control Practices*

Temporary Stream, Wetland & Soft Soil Crossings



Prepared by Carolyn Dindorf and Kseniya Voznyuk,
Minnesota Erosion Control Association
215 Hamel Road
Hamel, MN 55340
www.mnerosion.org

With assistance from:

Rick Dahlman, Mn Department of Natural Resources
Charlie Blinn, University of Minnesota
Dwayne Stenlund, Mn Department of Transportation
Dave Chura, Minnesota Logger Education Program
Dan Steward, Board of Water and Soil Resources

Cover Photos: MECA and MNDNR

Photo and Illustration credits are noted on each photo or illustration. If not indicated, photos and illustrations were provided by the Minnesota Erosion Control Association. Thank you to all who provided photos for this publication.

This project was funded in part by the Coastal Zone Management Act, NOAA's Office of Ocean and Coastal Resources Management, in cooperation with Minnesota's Lake Superior Coastal Program



December 2009 (Revision 1, February 2010)

TABLE OF CONTENTS

| | |
|--|----|
| Table of Contents | 2 |
| Introduction | 4 |
| Planning..... | 4 |
| The Importance of Planning | 4 |
| Evaluating the Site..... | 6 |
| Sources of Planning Information..... | 10 |
| Best Management Practices..... | 11 |
| Practices..... | 12 |
| Temporary Stream crossing options | 13 |
| Temporary Bridges..... | 15 |
| Timber/log Bridges..... | 15 |
| Lumber Stress-Laminated Bridge..... | 16 |
| Other bridge options | 16 |
| Ice Bridges..... | 17 |
| Culverts | 18 |
| Fords..... | 20 |
| Cable concrete ford..... | 21 |
| Pipe MAT/bundles..... | 21 |
| Temporary Soft Soil or Wetland Crossing Options..... | 23 |
| Corduroy/slash mat..... | 25 |
| Plastic Road..... | 26 |

| | |
|--|----|
| Wood Aggregate..... | 27 |
| Wood Mats, panels &Pallets | 27 |
| Ice Road..... | 29 |
| Other Products..... | 30 |
| Plastic arch | 31 |
| Ditch Bridge | 31 |
| Portable Mat Systems..... | 31 |
| Additional Considerations..... | 33 |
| Minimize Soil Movement and Grade | 33 |
| Landing/staging area tracking issues..... | 33 |
| Approaches..... | 33 |
| Erosion and Sediment Control..... | 34 |
| Erosion Control | 34 |
| Sediment control..... | 36 |
| Removing Materials and Restoring Grade | 38 |
| Vegetation | 39 |
| Closing Roads..... | 39 |
| Material sources | 40 |
| Glossary..... | 41 |
| References and Resources | 43 |
| Appendix A: Regulations | 46 |

INTRODUCTION

The purpose of this publication is to provide basic information on temporary stream, wetland and soft soil crossings in order to minimize impacts to water resources while providing stable access across them. The target audience is loggers, construction contractors and resource managers. Many of the practices covered in this publication can be constructed from materials available on site, recycled materials, or may be borrowed or rented. Most of these practices are low cost and reusable.

Poor logging and construction practices can increase sediment and other pollutants generated during storms. Douglass and Swank (1975) found an increase of 10 to 20 times more sediment generated from a poorly logged area versus an undisturbed area. A Wisconsin study found that sediment loads from two small construction sites were 10 times larger than typical loads from rural and urban land uses (USGS, 2000). Use of the practices recommended in this booklet can help minimize impacts to public water resources, help meet regulatory requirements, and help keep your operations productive.

PLANNING

THE IMPORTANCE OF PLANNING

Planning should be the first step in any successful project. With proper planning, many potential problems can be avoided and the project can proceed more efficiently. When dealing with wetlands, lakes and streams, several local, state and federal regulations must be followed. Many projects that impact surface waters require a permit. It may take two to three months or longer to obtain a permit. Planning can help you avoid costly delays and keep your operations productive. For example, identifying and avoiding soft soils means you won't have to spend a lot of time pulling equipment out of the mud.

If you are doing any work that affects a stream channel, you may need a permit. Check with the Department of Natural Resources (MNDNR) and other agencies (see Appendix A for more information).

There are federal, state and local regulations to prevent draining, filling and excavation of wetlands. Determination of a wetland boundary is not as simple as it may seem. There is a legal definition of a wetland that may not match what the lay person thinks is a wetland. Wetland delineation may be required in some cases. The length of the crossing may be longer than expected based on the legal wetland boundary. Some agencies' regulations include exemptions for certain roads that meet specific conditions. Check with each agency to learn if any exemptions might apply to your project (see Appendix A).

The Minnesota Wetland Conservation Act (WCA), the Minnesota Pollution Control Agency (MPCA) Water Quality Standards (MN Rule 7050) and the U.S. Army Corps of Engineers rules (Section 404) require a sequencing process for projects impacting wetlands. This includes 1) avoiding impacts, 2) minimizing impacts, and 3) mitigating impacts. Scouting the site for the crossing location with the least impact to a watercourse or wetland is recommended and should save time and money.

Planning the layout of the temporary road can help you minimize impacts due to erosion. Look for gradual grades and areas where soil movement can be minimized.

Part of the planning should include an evaluation of the best time of year to complete the project that would minimize impacts on the resources. Projects that can be completed during the winter months when soils and small streams are frozen can greatly minimize impacts. Spring conditions with high water and wetter soils should be avoided if possible. Waters designated by the MPCA as Outstanding Resource Value Waters (ORVW), trout waters, or impaired (303d-listed) waters may require additional or advanced best management practices (BMPs) in order to protect them from impacts. For streams, depending upon the fish species present, different times of the year are better than others (refer to the

MNDNR Publication “Best Practices for Meeting DNR General Waters Work Permit GP2004-0001” for specific information).

For most projects, reducing the amount of time the site is under construction and soil is exposed is one of the best practices to minimize environmental impacts. Following BMPs is not only beneficial for the environment; it also will be beneficial for the overall project in terms of minimizing soil movement and repairing areas. This will also save money.

EVALUATING THE SITE

Site evaluation leads to more efficient implementation and avoidance of problems. Scout the site to identify any special areas or features. Your site plan should include a sketch as well as a narrative of the proposed work, the order the operations will occur and how the site will be stabilized. Complete a sketch of the site to identify important features and the work areas. The sketch should include natural features such as streams, wetlands, ponds, rare plants, and steep slopes. The sketch should also include the layout of your operations, including temporary roads, access from public roads, concentrated work equipment activity area such as staging areas or log landings, stream or wetland crossings, landing or staging area, and location of spill kit and refueling and maintenance area, and portable toilet. Erosion and sediment control practices should also be noted. The example site plan on the next page shows many of the practices discussed in this booklet that could possibly be used on a site. The different BMPs should be used where appropriate depending on the specific site conditions and type and extent of disturbance. For example, a construction site which has greater soil disturbance will require more BMPs than a timber harvest area, where the soil is not disturbed to the same extent.

Your plan should include avoiding disturbance of,

- Steep slopes
- Archeological sites- contact the State Historic Preservation Office
- Dumps and areas of contaminated soils
- Erodible soils

- Soft soils
- Public waters- contact the area MNDNR office for a map of public waters
- ORVW, trout waters and impaired waters – check the MPCA web site for map searching tools at <http://www.pca.state.mn.us/water/stormwater/stormwater-c.html>.
- Ecologically sensitive resources-Minnesota's rare plants and animals, native plant communities, and other rare features (contact the MNDNR Natural Heritage Program at <http://www.dnr.state.mn.us/eco/nhnrp/nhis.html> to request a search)

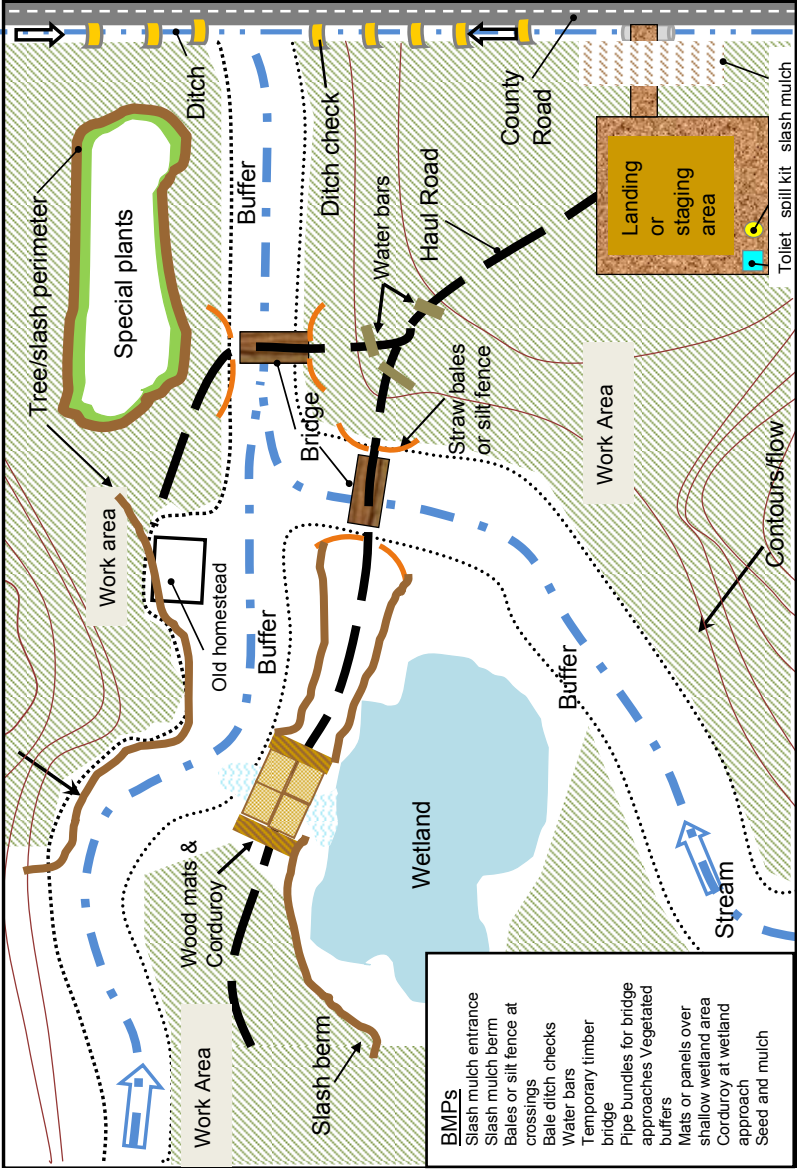

Site Plan overlaid on a USGS Quad map

If you are unable to avoid crossing a stream or wetland, walking the site and creating a sketch will help you identify the best place for placing the crossing to minimize impacts on the waters and other important features.

Choose a road access area that will help facilitate closing after work is completed. To increase the effectiveness of the closure, select an area that will be easy to close afterward, due to terrain, water, rocks, or trees. The entrance should be curved to limit the view into the forest or other area. An effective closure will help minimize unwanted vehicle access in the future.

How much weight can the ground handle?

Use the following table to help you estimate soil strengths using this simple penetration test. It is a rough estimate of a measurement known as the California Bearing Ratio (CBR), developed by the California Department of Transportation.

Estimated Consistency by:

| Feel | Sight | CBR% |
|-------------|---|-------------|
| Water | Person is wet | 0 |
| Very Soft | Person standing sinks more than 3 inches | < 0.4 |
| Soft | Person walking sinks about 2 to 3 inches | 0.4 – 0.8 |
| Medium | Person walking sinks about 1 inch | 0.8 – 1.6 |
| Stiff | Pickup truck ruts about 0.5 to 1 inch | 1.6 – 3.2 |
| Very Stiff | Loaded dump truck ruts 1 to 3 inches | 3.2 – 6.4 |
| Hard | Insignificant ruts from loaded dump truck | >6.4 |

Source: MN/DOT, 2007

Here's another simple measurement device to help you estimate what load your soils can handle. Construct this simple tool using a ½-in. diameter steel rod 2 ½ feet long with a "T" handle. Mark the rod at 6-in. increments from the bottom. Push the T-rod into the ground where you plan to drive. "If the rod goes in the ground 6-in., you may not need mats (or other options); 12-in., the tires will leave a 2-in. to 3-in. mark; 18-in., you're going to get stuck; 24 in., the truck is going to the frame right there.-in. (www.mudtraks.com).

SOURCES OF PLANNING INFORMATION

Depending on the type of project, there are several sources of information that can help you plan and prepare for projects that may impact wetlands, streams and other natural resources. More information on regulatory requirements and contacts is found in Appendix A.

Minnesota Logger Education Program (MLEP) - periodically holds workshops on planning road layout and other topics for loggers. <http://www.mlep.org/>.

Minnesota Department of Natural Resources

Forestry - can provide assistance to loggers with minimizing impacts and permit needs.

Waters - A DNR public waters work permit (application available under <http://www.dnr.state.mn.us/waters/forms.html>) may be required for work in streams, lakeshores and public water wetlands. For more information on MNDNR water permits, visit <http://www.dnr.state.mn.us/permits/water/needpermit.html> or contact the local area hydrologist.

Natural Heritage Information System- Information on Minnesota's endangered, threatened and special concern species for required searches in the project area is available through the MNDNR. <http://www.dnr.state.mn.us/eco/nhnrp/nhis.html>

Minnesota Board of Water & Soil Resources

Wetland Conservation Act (WCA)

<http://www.bwsr.state.mn.us/wetlands/regulation.html>

Minnesota Pollution Control Agency- contact for information on the National Pollutant Discharge Elimination System (NPDES) Construction Stormwater Permit.

<http://www.pca.state.mn.us/water/stormwater/stormwater-c.html>

Stormwater Compliance Assistance Toolkit for Small Construction Operators.

<http://www.pca.state.mn.us/publications/wq-strm2-09.pdf>

Minnesota Stormwater Manual

<http://www.pca.state.mn.us/water/stormwater/stormwater-manual.html>

County Soil and Water Conservation District (SWCD) – can provide information on Wetland Conservation Act requirements and erosion and sediment control practices. This is probably your best place to start to determine what the requirements are if wetlands will be impacted. Soil and Water Conservation District (SWCD) staff can point you in the right direction as far as what local government is in charge of WCA in the area and can help you understand the requirements of WCA. Most SWCD offices have United States Geological Survey (USGS) quad maps that can be viewed to help determine the best locations for crossings.

U.S. Army Corps of Engineers (Corps), St. Paul District, Regulatory Branch –wetland and navigable waters Federal regulations. <http://www.mvp.usace.army.mil/regulatory/>.

University of Minnesota Extension- offers fact sheets and publications on forest management and crossings.

BEST MANAGEMENT PRACTICES

Best management practices (BMPs) are activities and methods used to minimize erosion and the impacts of stormwater runoff on our waters.

Limit the area of disturbance, especially areas where bare soil is exposed. Install perimeter controls such as slash berms or silt fence prior to disturbing soils. Stabilize any disturbed areas concurrent with work. Don't wait until the entire project is completed. Temporary seeding and weed-free mulch are good options for areas

that will be disturbed again. Permanent seeding with weed-free mulch is appropriate for sites that will no longer be disturbed. For steeper grades, other erosion control practices may be needed, such as blankets or wattles. See the section on Erosion and Sediment Control for more information.

- Streams should be crossed in a narrow straight reach, rather than on a bend.
- Crossings should be installed as close to a 90° angle to the stream as possible. Look for solid bank material, rock or firm cohesive soils and a low gradient and short slope for approaches.
- The approaches can be as much of an environmental problem as the crossings themselves. They should be designed to minimize impacts and divert water away from exposed soils. Temporary and permanent soil stabilization methods must be implemented
- Maintain a filter strip of undisturbed soil ground-cover vegetation around streams and wetlands. A filter strip is a width of vegetation between water and an upland area which helps infiltrate runoff water and trap pollutants before they reach surface water.

PRACTICES

The primary sources for the information in this section are given below. Additional resources are listed at the end of this publication.

Blinn, Charles R.; Dahlman, Rick; Hislop, Lola; Thompson, Michael A. 1998. Temporary stream and wetland crossing options for forest management. General Technical Report NC-202. St. Paul, MN: U.S. Dept. of Agriculture, Forest Service, North Central Forest Experiment Station.

Temporary Stream Crossings. 2002. Univ. of Minnesota Extension. www.extension.umn.edu/distribution/naturalresources/DD7001.html.

Wiest, Richard L. 1998. A Landowner's Guide to Building Forest Access Roads. Technical Publication NA-06-98. Radnor, PA: U.S. Dept. of Agriculture, Forest Service, Northern Area State & Private Forestry.

TEMPORARY STREAM CROSSING OPTIONS

Properly designed and installed temporary water crossings can greatly reduce costs and meet the concerns of regulatory agencies. Please note that operating equipment near perennial or intermittent stream channels may deposit sediment directly into the stream.

The four most commonly used stream crossing structures are bridges, culverts, fords and ice bridges. Generally fords, culverts and ice bridges cost less to build and maintain than timber bridges and pipe bundles.

Before the construction of a temporary crossing, it is important to consider the type of crossing, the installation and removal budget, as well as the weather conditions. While some stream crossing options, such as fords, may have lower installation costs, they may have higher maintenance costs, may not satisfy regulatory requirements, or might not provide enough support or traction. Use the following chart to help determine the type of stream crossing best suited for your project.

Temporary Stream Crossing Options

| Type of Crossing | Stream Conditions | Uses | Cost | Maintenance | Potential Problems |
|----------------------------|---|--|------------|-------------|--|
| Temporary Bridges | Small stream, maximum span <16-ft.; firm, stable <30-ft. bank | Deep water, larger spans, steep banks | Low - Med | Low | Requires proper design, engineering study |
| Ice Bridge | Slow velocity, dry or frozen streams | Winter crossing over open water | Low | Low | Melting, limited season. Need source of water |
| Culvert | Narrow streams with well-defined channels. | Channel up to 2-ft. deep | Low - Med | High | Blockage by debris, sediment, may require engineering design |
| Ford | Shallow (<2-ft. water), low velocity, hard bottom | Intermittent stream Infrequent use | Med | Low - Med | Sediment suspension, pollution from vehicles |
| Ford-Cable Concrete | Shallow (<1-ft. deep), low velocity(<5fps), soft bottom | Intermittent stream | Med | Low | Maintain elevation of stream channel or creates obstruction |
| Pipe Mats/Bundles | Narrow, Shallow, low flow | Pipe may be used as fill around culverts | Med | High | Blockage by debris, sediment |
| Other Options | Depends on product | Depends on product | Med - High | Med - High | Varies by option |

TEMPORARY BRIDGES

Bridges are the most efficient stream crossing option for keeping sediment and equipment out of the stream. Bridges may be needed for deeper water streams, larger spans, steep stream banks and waters classified as ORVWs, trout waters or impaired. A temporary bridge can be an effective method of crossing the stream with the least disturbance to the water. Temporary bridges can be constructed out of various materials such as timber, railroad cars, railroad ties, logs, steel or pre-stressed concrete. It is preferable that bridges are installed on abutments on both sides of a stream. This creates steady and even support, protects the stream bank, and facilitates removal, particularly when the ground is frozen.

TIMBER/LOG BRIDGES

Timber /log bridges make use of on-site materials. They can be constructed with or without planks on top. The planks provide more stability and also reduce the amount of soil that may fall into the stream from vehicle tires.



Uses and Considerations:

- Anchor bridge to nearby tree in case of high water conditions.
- Stabilize the approach with fill or other materials (e.g. pipe bundles, corduroy).
- Engineering may be required to ensure loads will be supported.

LUMBER STRESS-LAMINATED BRIDGE

A stress-laminated lumber bridge is composed of two or more panels, each 8-in. deep and 4 ft. wide. They can be installed by crane or backhoe. Panels may be attached using steel couplers. It is important to move the panel as close together as possible to catch any material before it falls into the stream. The panels are held in place on the banks using spikes. Each end is supported with an 8-in. x 8-in. abutment. As the bridge is being used, it is important to inspect it periodically to make sure that the bolts don't become loose.

Sources: Rental bridges may be available through several sources. Check with your County Forestry Department or Area MNDNR office.



OTHER BRIDGE OPTIONS

There are several other options for bridges, including prefabricated



bridges made of old railroad cars or flatbed truck trailers.

metal, metal/wood combination, pre-stressed concrete and



ICE BRIDGES



Photo courtesy of Boise-International Falls

3.8.2000

An ice bridge is a common winter stream crossing. In some areas, the ice is thick enough that construction is not needed. Where required, ice bridges are constructed by packing snow or pumping water onto

existing ice. Cold weather is essential for constructing ice bridges. Night temperatures below 0 degrees Fahrenheit are ideal. (Blinn et al., 1998).

Use the following chart or formula to help you estimate the minimum ice thickness required to support a given load above a flowing river or stream (University of Mn Extension, 2002. Forest Management Practices Fact Sheet Crossing Options Series #4, from Haynes and Carey, 1996).

$h = 4(P)^{1/2}$ Where, h = ice thickness in inches,

P = the load or gross weight of the vehicle plus its contents, in tons.

| Vehicle class** (tons) | Minimum ice thickness (inches) | Minimum distance between vehicles*** (feet) |
|---------------------------|-----------------------------------|---|
| 0.1 | 2 | 27 |
| 1 | 4 | 34 |
| 2 | 6 | 48 |
| 3 | 7 | 58 |
| 4 | 8 | 67 |
| 5 | 9 | 75 |
| 10 | 13 | 106 |
| 20 | 18 | 149 |
| 30 | 22 | 183 |
| 40 | 26 | 211 |

Uses and Considerations:

- Ice bridges cannot be used in fast-moving streams
- Use snow and ice only, not brush and logs. They do not provide support, but create more debris.
- Ice quality is important. Make sure it is clear, solid, uniform in thickness, not bubble-filled, etc.
- If bubbles are present, thickness required should be doubled.
- Does not have to be removed when work is completed.
- Ice bridges may cause channel blockage on some streams, which can cause excessive bank erosion during spring snow melt.
- The condition of the bridge should be checked frequently, especially if the stream is fast moving or if the temperatures warm.

CULVERTS

A culvert is a structure that carries water under a road or trail. Unlike many other temporary stream crossing options, culverts almost always require a permit. The culvert inlet should always be installed at the same level or slightly below the existing stream bed. The



Photo courtesy MNDNR

outlet should be installed lower than the inlet. Both the length and the width of the culvert should be considered. Pay special attention to the culvert size, as undersized culverts can become obstructed with sediment. Culvert sizing is based on drainage. Multiple culverts with clean washed riprap can be used for wider streams or ditches. However, a single larger culvert is generally better than several small culverts. Check with your County SWCD for assistance in determining drainage area and culvert size.

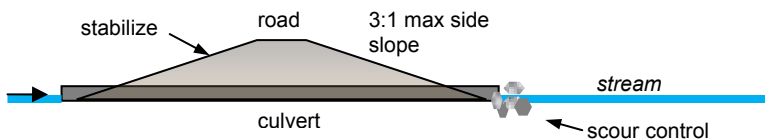

The minimum recommended culvert diameter is 12 in. or 30-cm. (Blinn et al., 1998). For culverts under long-term temporary roads, the culvert must be appropriately sized for the hydrology.

Culverts should be designed to maintain stream stability as well as fish passage using the Match, Extend, Set, Bury, Offset, Align, Consider (MESBOAC) design procedures (Hansen et. al, 2009), www.lrrb.org/pdf/200920.pdf.

- 1 Match culvert width to bankfull stream width.
2. **Extend** culvert length through the side slope toe of the road.
3. **Set** culvert slope the same as stream slope (failure to set culverts on the same slope as the stream is the primary reason that many culverts impede fish passage).
4. **Bury** the culvert 4 to 12 inches into the stream bottom. For culverts 2 to 6 feet in diameter, recess 10 to 18 inches below the stream bottom.
5. **Offset** multiple culverts.
6. **Align** the culvert with the stream channel.
7. Consider headcuts and cutoffs.

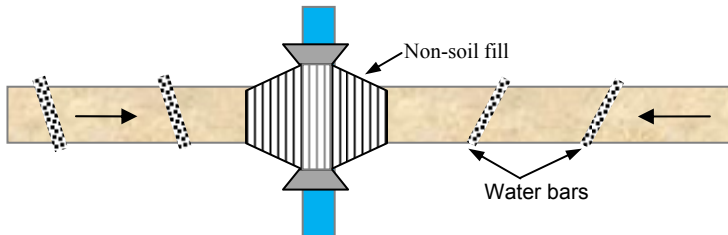

Uses and Considerations:

- Culverts should be used for narrow deeper streams or ditches.
- Avoid soil fill. Instead fill the void surrounding the culvert with pipe bundles, logs or clean rip rap whenever possible.
- Place the culvert at or slightly below the existing bottom elevation.
- Make sure culvert extends beyond fill.
- Stabilize side slopes and culvert ends.
- Use scour control such as riprap at ends of culvert.



FORDS

Fords are low-water crossings best suited for short term use. Because it directly disturbs the stream bottom, it is the least desirable option. Every time a vehicle crosses it is disturbing the bottom sediments and washing soil off the tires into the stream. Fords use the streambed as part of the crossing trail and should be limited to periods of low water flow when the water is less than 1-ft. deep. A dry streambed will make the placement and compaction of fill



Photo courtesy University of Mn Extension

much easier and will minimize sediment movement. It is also suggested to construct a sediment trap below the ford to catch any sediment introduced by the construction of the ford. It is important to note that in some states, such as Minnesota, operators may need a permit to build a ford crossing (see Appendix A).

- If a firm rock or gravel base is not present, the bed must be stabilized by adding material such as crushed rock, riprap, cable concrete or rubber mats. Any structure placed in the stream must be tethered to aid recovery in case of flooding.
- Ford construction should not take place during fish migration periods.
- Machines crossing the stream over a ford may be directly in the water. It is essential that all equipment and machinery is clean and does not have any leaks.
- If the streambed is not dry, the water flow should be diverted using pipes, pumps or ditches during construction of a ford.

Uses and Considerations:

- Intermittent stream channel when it is dry, or permanent channel during low water flow periods.
- Choose a straight reach of the stream with shallow water and easy (gently sloping) approaches.

- Install lead-off ditches or water bars on roads approaching streams to divert water into vegetation away from the stream.
- Where necessary, stabilize banks and approaches by placing a layer of clean material such as gravel or crushed rock over a woven geotextile. Use temporary options such as wood mats, wood panels or pallets, and expanded metal grating to stabilize approaches.
- Generally fords are poor choices unless the stream is dry, and most likely not approvable for use in ORVW, trout waters or Impaired Waters.
- If stream is flowing, fords should not be used in streams with a water depth greater than 1 foot.
- Maintain the natural bottom elevation of the streambed to allow fish passage.
- Keep all vehicles which construct or use the crossing in good condition to prevent pollution of the water (i.e., no fluid leaks).
- Reseed and mulch bank cuts immediately to prevent them from eroding into the stream.
- Remove any temporary surfacing materials and abutments when the ford is no longer in use.

CABLE CONCRETE FORD

Cable concrete fords (also known as articulated concrete mats) are another option for crossings. Prefabricated mats of concrete can be placed in a dry or intermittent streambed to distribute the weight of the vehicle more evenly and provide a stable crossing. They must be removed when the logging or construction is completed.



PIPE MAT/BUNDLES

HDPE (high-density polyethylene) pipes can be used to construct temporary stream crossings. Pipes are connected together using cable to form mats. The mats are then placed on top of a non-woven

geotextile fabric. The pipe bundles are usually used in small streams that are less than ten feet wide and four feet deep. The water in the stream should be slow-moving and free of debris in order to pass through the pipes.

HDPE construction materials can be purchased from hardware or plumbing supply stores. The pipe bundles are easy to construct, install and remove. PVC is not recommended as it is more susceptible to UV light deterioration. The pipe bundles must be regularly inspected as the HDPE pipes can become plugged with debris and sediment.

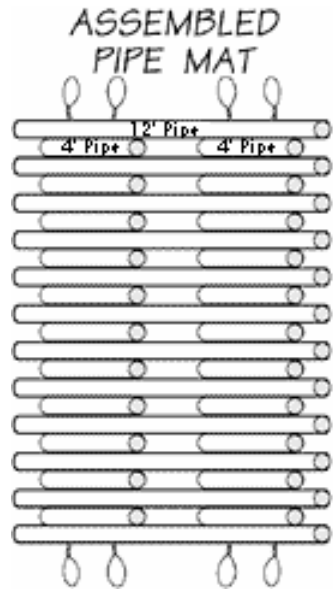

Illustration: Univ. of Mn Extension



Uses and Considerations:

- HDPE construction materials can be purchased from hardware or plumbing supply stores. The pipe bundles are easy to construct, install and remove.
- PVC is not recommended as it is more susceptible to UV light deterioration. HDPE Pipes can become plugged with debris and sediment.
- The pipe bundles must be regularly inspected.

TEMPORARY SOFT SOIL OR WETLAND CROSSING OPTIONS

There are several wetland crossing options, such as pipe mats, plastic road, corduroy, wood aggregate and wood mats. Generally, wetland crossing options are enhanced by the application of a root or slash mat or geotextile that will provide additional support.

| Type of Crossing | Conditions | Uses | Cost | Maintenance | Potential Problems |
|-------------------------------------|---|---|-----------|-------------|---|
| Corduroy or Slash Mat | Wetlands & Soft Soils CBR % <0.4 | Minimizes rutting and compaction, allows surface and subsurface water movement & provides support | Low | Low | Works best in combination with geotextile, if left in place, may limit plant growth |
| Pipe Bundles/ Plastic Road | Shallow CBR% >0.4 | Minimizes rutting and compaction, allows surface and subsurface water movement & provides support | Med | Med | Works best in combination with geotextile |
| Wood Aggregate | Wetlands & Soft Soils | Minimizes rutting and compaction, may be used for longer distances | Low | Low - Med | Works best in combination with geotextile |
| Wood Mats, Panels or Pallets | Soft Soils CBR% <0.4 | Minimizes rutting and compaction, allows surface & subsurface water movement & provides support | Low - Med | Low | Mats and panels are heavy, works best in combination with geotextile |

| Type of Crossing | Conditions | Uses | Cost | Maintenance | Potential Problems |
|----------------------|---|--|------------|-------------|---|
| Culvert | Wetlands and shallow water | Allows surface and subsurface water movement | Low -Med | High | Blockage by debris & sediment |
| Ice Road | Wetlands & soft soils CBR% <0.4 | Minimizes rutting and compaction | Low | Low | Melting, limited season. May need to remove or flatten vegetation and snow or add water to promote freezing |
| Portable mats | Wetlands and soft soils, CBR% 0 for some products, >1.6 for others | Lighter ones work well for hard to access areas, heavier mats work well for shallow wetlands | Med - High | Low | |

CORDUROY/SLASH MAT



Courtesy University of Mn Extension

direction of travel. Flotation will increase with increasing surface area. In some crossings, multiple layers of corduroy may be required.



Photo courtesy MNDNR



Photo courtesy MNDNR

The advantage of this method is the ability to use materials from on site.

Corduroy/slash mats are usually not removed from the site when the operation is completed. However, although they are biodegradable, they can be unsightly, can limit plant growth and are a fire hazard. Removal of slash or corduroy can be accomplished by scattering or burning in place, piling and burning, shredding and scattering or chipping and hauling (USDA Forest Service, 2008). If non-biodegradable geotextile is used, the geotextile should be removed when work is completed.

Uses and Considerations:

- To be effective, slash mats should cover the ground and be 6-in. thick or more.

- Mats made of smaller brush work better if branches are interlocking.
- Nonwoven geotextile placed over the soil is optional, but reduces the amount of corduroy needed for an effective crossing.

PLASTIC ROAD

Plastic road mats are used for crossings over wetland soils. They are similar to pipe mats, but are connected with PVC. These types of crossings work best over existing root or vegetation mats. HDPE pipe mat crossings are built by cabling together HDPE (high-density poly-ethylene) pipes to form mats. Plastic road crossings are constructed by linking together HDPE mats using a 1-inch PVC stringer. The plastic road includes transition mats made from successively smaller pipe (4-in. to 2-in.) to ease the passage of tires up to and down from the crossing. Both options help protect wetland haul roads from rutting by distributing the load across the surface (USDA, 1996).



Uses and Considerations:

- Materials can be purchased locally and plastic road can be assembled on site.
- Multiple mats can be linked to span the required distance.
- They are lightweight, portable, inexpensive and reusable.
- Water can flow through the pipes instead of over the crossing.

WOOD AGGREGATE

Wood aggregate consists of wood chips or chunks that are used as fill materials for crossing loose soils. Wood is the best material for this crossing method due to the fact that it is lighter than other materials and has better natural flotation. Wood is also biodegradable and does not have to be removed after construction. The depth of the wood aggregate is determined by the soil conditions on the site.

Saturated organic and mineral soils require at least 12 inches of wood aggregate. Soft sand generally requires less aggregate. Wood aggregate can be used with or without geotextile, however a layer of geotextile will improve performance and reduce the depth of the aggregate needed.



Uses and Considerations:

- Use a wood aggregate depth of 24-in. or more for best results (12-in. minimum). Use wood chips or larger chunks. A small amount of sawdust, planer chips and bark fibers can help form a well-compacted layer for traffic (Mullis and Bowman, 1995).
- Inspect and repair ruts as needed.
- The advantage to this method is the ability to use materials from on-site.

WOOD MATS, PANELS & PALLETS

Wood mats are constructed out of logs or cants (sawn dense hardwood) and connected together with cables to make a single layer crossing. Longer logs are more useful in the case of a heavy load or very loose soil.



Photo courtesy John Thomas



Several design options for wood mats are shown. Note that some use wood running parallel to the direction of travel and some are perpendicular to the direction of travel.

parallel to the direction of travel and some are perpendicular to the direction of travel.

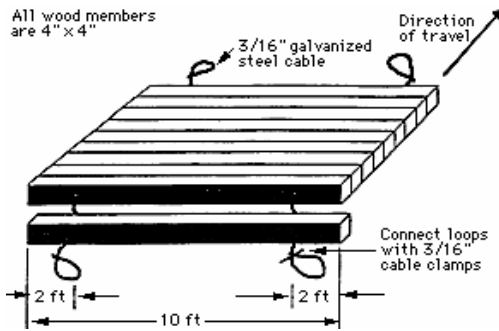

Illustration courtesy University of Mn Extension

Wood panels consist of two layers that are constructed by attaching parallel wood planks to perpendicular wood planks using nails. The perpendicular planks should be located where the vehicle tires will pass (about 6 feet apart). The running surface can be placed on

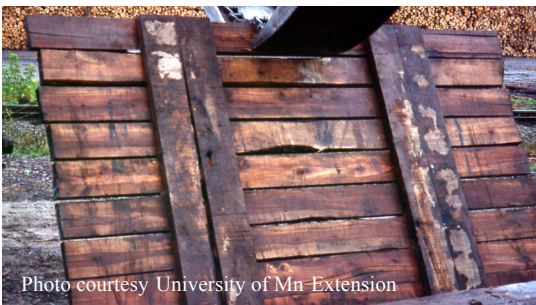

Photo courtesy University of Mn-Extension

either side as long as nails aren't protruding.

In order to reduce rocking, it is useful to interconnect adjacent panels. This also improves overall flotation of the

crossing. Adjacent panels can be interconnected using eye-hooks

screwed into the end of each panel with quick links or other heavy duty connectors through the hooks.

Wood pallets are similar to shipping pallets, but are sturdier and made to support traffic. They are prefabricated, commercially

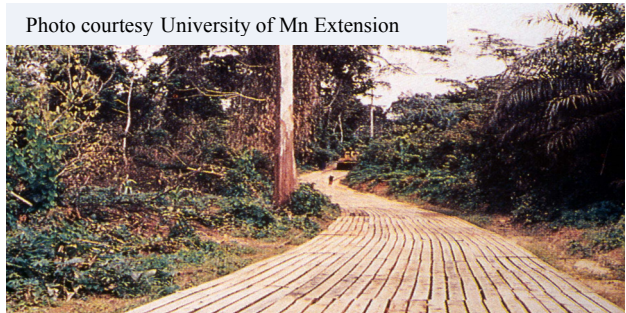

available 2 to 3 layer pallets usually made from dense hardwood. They can be interlocked and used over long distances.

Uses and Considerations:

- Wood mats and panels can be constructed on site and are easy to build and maintain.
- If the surface is slick, expanded metal grading can be added to provide better traction.
- Under normal use, a wood mat is expected to last for several years. Individual wood mats can be connected to construct a complete crossing.
- Wood mats can be used in flat areas on wetland or soft soils and to help stabilize stream crossing approaches. They are best used for hauling or forwarding operations (University of Mn Extension, 2002).



ICE ROAD

An ice road is a common and inexpensive method of crossing over soft soils and wetlands during winter months. An ice road is created by packing down vegetation and snow and/or removing snow so that frost can penetrate to freeze down the road. Snow shoes, a

Photo courtesy Dwayne Stenlund



snowmobile or an ATV can be used to pack the snow down initially and allow the frost to penetrate. Heavier equipment can be used once the ground freezes. The width of area packed and plowed needs to be wide enough to provide a frozen surface for snow plowing equipment to push snow off the road, and

periodic turn-out spaces to allow vehicles to pass when they meet. In open areas the width may need to be 50 to 100 feet wide to keep the roadway from blowing shut with snow. It is important to periodically check conditions to make sure the ground is frozen solid enough to prevent rutting and damage to plants.



Photo courtesy MNDNR

In areas where the ground freezes seasonally, winter logging can be less harmful to the environment than summer logging. Winter logging minimizes soil compaction, introduction of exotic invasive species and direct loss of uncommon or rare understory plant species (Wolf et. al., 2007).

OTHER PRODUCTS

Disclaimer: Mention of products in this publication does not indicate endorsement. Please note there are likely other similar products that will work for temporary crossings that are unintentionally not included in this publication.

PLASTIC ARCH



Photo courtesy MNDNR

Large plastic pipe cut in half can be laid over a narrow, shallow stream for a temporary crossing. Logs or smaller plastic pipe can be placed as fill along each side of the pipe to stabilize the approach. One manufacturer noted that the plastic arches had supported a weight in

excess of 25,000 lbs.

DITCH BRIDGE



Photo: SVE Portable

These prefabricated portable ditch bridges are made of aircraft grade aluminum. They are sold in pairs and can be made in lengths of up to 24 feet long. The bridges are placed using trucks that are likely already on-site. These portable bridges can be used to cross

narrow ditches and streams and can carry vehicle weights of up to 65,000 lbs.

Source: SVE Portable Roadway Systems, Inc.
800-762-8267. www.mudtraks.com.

PORTABLE MAT SYSTEMS

There are several manufacturers of portable mat systems. These are reusable mats made of composite fiberglass or high density polyethylene. They generally can be interconnected to extend over the area needed. Depending upon the product, they can be used in soft soils or wetlands. Most of these mats may be either purchased or rented. Three products are listed below.

Dura-base Composite

Mat System mats are made of high density polyethylene and will last for 15 to 20 years. Mats are 8-ft. x 14-ft. or 8-ft. x 7.5-ft. and can be interlocked to cover large areas or long stretches. Equipment is needed for installation as each mat weighs 550 to 990

pounds. The mats can support loads up to 600 psi.

<http://www.newparkmats.com/content/view/28/>.



Minnesota source (may be rented): Gary Carlson Equipment

www.garycarlsonequip.com.

Mud mats are a preassembled product consisting of a double-wall, high strength fabric with pockets containing high tensile reinforcing ribs running perpendicular to the direction of traffic. They are 15 feet long by 8 feet wide. The mats can be interlocked to increase length or width using built in straps. Mud mats are lightweight, washable, and reusable and can be rolled up for easy transport.



Minnesota Source: Brock White Company www.brockwhite.com

Mud-Traks Super Mats are lightweight composite fiberglass panels appropriate for soft soils (where a 200-lb. man walking leaves a 1 to 2-in. deep footprint).

SVE Portable Roadway Systems, Inc. 800-762-8267
www.mudtraks.com .



Minnesota Source: Neaton Companies www.neatonbrothers.com.

ADDITIONAL CONSIDERATIONS

MINIMIZE SOIL MOVEMENT AND GRADE

Minimizing impact is one of the best management practices you can use to protect the water resources. Limit the area of disturbance as much as possible. Use contours, existing site conditions and site generated materials for protection. Choose crossings with a low grade approach and make use of diversions and water bars to minimize erosion. There are many erosion control methods listed in this publication that should be used to stabilize bare soils as soon as possible. Preventing erosion is much more efficient and cost effective than trying to repair eroded stream banks and slopes and removing sediment from streams and wetlands.

LANDING/STAGING AREA TRACKING ISSUES

Site access often results in tracking of soil onto paved surfaces. Entrance pads constructed of wood chips, corduroy, slash or gravel can minimize tracking. Driving over the pad helps dislodge soil from tires. Maintenance of the access pad is required to keep it functional. For example, rock may require removal and cleaning, or additional chips can be added to a wood chip pad. Geotextile placed under the pad helps keep it from sinking into the ground and aids removal when the construction or logging operation is completed. In addition to rock and on-site materials, there are some manufactured products that can be used to prevent tracking (see Portable Mat Systems above). Efforts need to also be taken to minimize tracking soil and mud onto roadways, and daily road sweeping must be included in the site management BMPs to keep the road surface clear of sediment, when necessary.

APPROACHES

Approaches to crossings are prone to erosion. Look for a site with a flat approach rather than a steeper bank. Use temporary diversions to direct clean water away from the road or skid trail and into a stable vegetated area. If possible, use slash, brush, corduroy or other

materials to stabilize approaches rather than soil fill. For bridges, make use of ramps or pipe bundles for the approach. Bridges should extend well beyond the stream banks to provide stable approaches. Periodically inspect approaches and repair as needed. Once work is completed and the crossing is removed, stabilize the area using the erosion control methods listed below.

EROSION AND SEDIMENT CONTROL

Erosion and sediment control practices should be a part of every project. Erosion control is the prevention of movement of soil. Sediment control is the trapping of eroded soil before it reaches water. Erosion control is the first line of defense and is much more effective than sediment control. It is very important to use erosion and sediment control practices to minimize impacts on streams, lakes and wetlands. There are many options available. To control sedimentation, down gradient perimeter control measures must always be installed prior to any construction or grading activities. Erosion and sediment control products are available from several sources (see Material Sources section). In many cases you can make use of on-site materials such as wood slash or chips for both erosion and sediment controls. Descriptions of many of the practices are provided below.

To be effective, all erosion and sediment control practices must be inspected and maintained regularly, especially after rain events. Materials may need to be replaced or repaired and sediment removed. Document inspections and track maintenance activities in a maintenance log. Note any changes to the site plan. If a practice is not working, try something else.

EROSION CONTROL

- **Compost** Compost is organic soil derived from plant material such as wood, leaves and grass. It is blown or spread over a bare area provides erosion control as well as a good seed bed. Seed can be incorporated with the compost. Fibers in the



compost prevent movement of the compost during rain events.

- **Erosion control blankets**

Blankets composed of straw, wood fiber, coconut fiber or a combination of these materials are installed over seeded bare soils to prevent erosion. They come in rolls and are installed using sod staples or biodegradable stakes. Wood fiber blankets

(derived from the wood industry) provide very effective erosion control for ditch and conveyance bottoms. The blanket is generally installed in the direction of flow or up and down a slope, overlapped and trenched at the top.



- **Hydroseed/hydromulch** is a method of restoring vegetation using a slurry to spray seed and mulch onto the ground. Often, a tackifier is added to help the mulch stick to a slope. It requires special equipment to install. It works well for large areas and steep slopes.

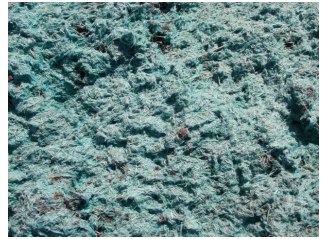

- **Mulch** Straw, hay, wood fibers or chips, expandable pellets are placed over bare soils or newly seeded areas to reduce erosion and provide protection during vegetation establishment. Straw or hay mulch should be certified as weed free



from sources inspected by the Minnesota Crop Improvement Association. If not weed free, state listed noxious weeds may compete with re-growth of the forest community and affect the future of the industry.



- **Plastic** Sheets of plastic can work as short-term temporary erosion control. The plastic covers the slope and prevents rain

from dislodging the soil particles. Plastic or tarps may be used to cover small temporary stock piles too.

- **Temporary pipe down drains** Corrugated plastic or metal pipe may be used to carry concentrated flow from the top of the slope down to the bottom so that it doesn't flow through disturbed areas and cause erosion. Diversion berms are used to direct water to one or more areas where it can enter the pipe. The pipe outlet must be stabilized with rock riprap or other means.
- **Vegetation** Vegetation provides the best erosion control. Vegetation should be reestablished as soon after construction as possible. Be careful not to introduce invasive species in a seed mix. Seed mixes and sources are listed in the Material Sources Section of this publication.
- **Water bars or diversions**
Temporary water bars and diversions are ridges made of compacted soil, logs or others materials installed above the construction area or in a road or slope to divert clean water away from the disturbed areas. Several diversion structures can be used down a slope to dissipate energy on the road and route runoff to stable areas. Energy dissipation must be provided at the downstream end of the diversion. This includes rock rip rap, erosion control blanket, dense vegetation and other devices.



SEDIMENT CONTROL

- **Brush barriers** are piles of leftover tree branches and vegetation debris that is used for perimeter sediment control.
- **Ditch checks** Rock, wood fiber or straw logs, and pre-fabricated products staked in ditches are used to decrease flow velocities and trap sediment.



- In-stream sediment control** There are several products that can be used to trap sediment that makes its way into the stream. They are placed on the stream bottom, anchored with rock or stakes, and must be removed when full of sediment. If biodegradable, the sediment-laden mats can be used for erosion control on adjacent bare stream slopes.



- Logs or socks** filled with wood chips, compost or rock may be used as down slope perimeter control or as mid-slope checks to help slow down the runoff.



- Sediment Traps** are small excavated areas used to trap sediment from runoff. Runoff is directed into these shallow ponds.

- Silt Fence** is a geotextile material generally installed on the contour at the bottom of the slope to trap sediment that erodes from a site. The bottom of the silt fence is buried 6-in. and staked at 4-6-ft. intervals on the down-slope side of the fence.



- Site Access**-Tracking soil onto paved roads is not an acceptable practice. Construction/logging site exits should be prepared so that soil is removed from truck tires before they hit the pavement.

Several options exist. Protect access points with wood chips, corduroy logs, wooden mats, or slash o prevent soil or mud from being tracked onto the paved road.

A more expensive alternative is a bed of rocks constructed of 1 ½ - 3-in. clear aggregate 6-in. thick placed over geotextile fabric. Another alternative is a



prefabricated product such as the mud mat, a reusable product (See Practices section).

- **Straw bale dikes** Straw bales are placed in a shallow trench and staked in place on the contour at the bottom of the slope to catch sediment.



- **Wood chip berms** Piles of wood chips or shredded wood can be placed at the bottom of the slope or around the perimeter of a site to capture sediment.



- **Wood Slash Berms** may be used as perimeter control. Brush is carefully piled and packed down to act as a temporary filter barrier to slow runoff and capture sediment. Berms may be used around wetlands, streams or other special areas to prevent sediment from reaching these sites. Be aware that operation and transport of wood slash may be limited to prevent the spread of the Emerald Ash Borer.



REMOVING MATERIALS AND RESTORING GRADE

Once operations have been completed, all materials should be removed from the area and the grade restored. Compacted areas should be tilled to promote vegetative growth. Large ruts should be filled in. Slash may be left in place if not so thick as to prevent plant growth. If non-biodegradable materials, such as geotextile, were used, they should be removed from the area and properly disposed or reused. Silt fence should be removed once the vegetation has been restored and the area stabilized. If you don't want to remove materials once the project is complete, make sure biodegradable or natural products are used.

VEGETATION

Native seed mixes should be used to establish vegetation on disturbed areas. The seed mix should be from a source as close to the project site as possible. Cover crops may be needed to establish vegetation quickly on highly erodible areas. Do not use seed of non-native invasive species such as Reed Canary Grass or Crown Vetch.

Temporary cover should be used for areas that are not ready for final cover but are prone to erosion. Use a seed mix appropriate for the moisture conditions.

The Board of Water and Soil Resources (BWSR) has some recommended native seed mixes that are carried by some native seed nurseries. The mixes are listed by the type of community. There are several mixes appropriate for forest edges and wetland areas, temporary and permanent. The seed mixes are found on the BWSR web site at:

<http://www.bwsr.state.mn.us/wetlands/vegetation/index.html> along with instructions on how to use the mixes and seed vendors.

The Minnesota Department of Transportation also has a list of seed mixes for various environments.

<http://www.dot.state.mn.us/environment/erosioncontrol/seedmixes.html>.

CLOSING ROADS

Once logging operations are completed, the roads should be properly closed. Old logging roads are often targeted by off highway vehicles (OHVs). They can cause a lot of damage to the area. Block the road



Photo courtesy MNDNR

entrances with large stumps or rocks. The more you can do to make it look like it isn't a road, the less likely it will be used. The photo on the left shows root wads and slash used to block off a temporary road to close it.

MATERIAL SOURCES

Minnesota Board of Water and Soil Resources (BWSR)

Recommended native seed mixes for various sites can be found on the following web site.

<http://www.bwsr.state.mn.us/wetlands/vegetation/index.html>.

Minnesota Department of Natural Resources (MNDNR)

Temporary Crossings – the MNDNR may have some temporary crossing materials available or will know of other sources. Contact your area office.

Seed- a list of native seed nurseries by areas of the state is available on the MNDNR web site.

<http://www.dnr.state.mn.us/gardens/nativeplants/index.html>.

Minnesota Department of Transportation (MN/DOT)

Seed- list of seed mixes- a list of seed mixes (native and non-native) is available in the MN/DOT seeding manual.

<http://www.dot.state.mn.us/environment/erosioncontrol/seedmixes.html>.

Erosion and sediment control specifications – MN/DOT also has a document with information and specifications for erosion and sediment control practices for construction projects.

Minnesota Erosion Control Association (MECA) maintains a directory of suppliers and installers of erosion and sediment control products. These include blankets, hydromulch, geotextiles, culverts, seed, portable mats, and more. www.mnerosion.org/directory.

Minnesota Logger Education Program (MLEP) - may have information on bridges available for rent. www.mlep.org (218) 722-5442.

GLOSSARY

Abutment: structures such as header logs, timber cribbing, concrete pads or other solid material installed on a streambank to provide level, stable support for bridges.

Best Management Practices (BMPs): practically and economically achievable practices for preventing or reducing nonpoint source pollution.

Corduroy: logs, brush or slash placed over a wetland area to reinforce the natural root mat with the purpose of minimizing the risk of foundation failure.

Erodible soils: soils likely to have high soil detachment when exposed to water runoff.

Erosion: removal of solids such as sediment and rocks from the natural environment.

Erosion control fabric: a method of stabilizing soil with a reinforced structure that is usually composed of jute or other biodegradable material. It is used to cover the ground surface to prevent erosion.

Ford: a low water stream crossing that makes use of the streambed, and where tread is reinforced to bear intended traffic. It is a location, usually an intermittent or dry streambed, where a shallow stream may be crossed by a vehicle.

Geotextile: a product used as a soil reinforcement agent and as a filter. It is constructed with synthetic fibers manufactured in a woven or loose non-woven manner to form a blanket-like product.

Grade: the slope of a road expressed as a percent of change in elevation per unit of distance traveled.

Mulch: a natural or artificial layer of plant material or other material covering the land surface that conserves moisture, holds soil in place and aids in establishing plant cover. It also minimizes temperature fluctuations.

Nonpoint source pollution: occurs when rainfall or snowmelt runoff carries pollutants into streams, lakes, groundwater and wetlands.

Runoff: the water that flows off of a site after a rainfall or snowmelt.

Rut: a depression made by the passage of a vehicle or equipment.

Sediment: solid material that is in suspension, is being transported, or has been moved from its site of origin.

Silt fence: a temporary barrier used to intercept sediment-laden runoff from small areas.

Slope: the degree of deviation of a surface from the horizontal, measured as a numerical ratio, as a percent, or in degrees.

Wetland: areas that are inundated or saturated by surface or groundwater at a frequency and duration sufficient to support, and that under normal circumstances do support, a prevalence of vegetation typically adapted for life in saturated soil conditions. Wetlands do not always have open water.

REFERENCES AND RESOURCES

Blinn, Charles R.; Dahlman, Rick; Hislop, Lola; Thompson, Michael A. 1998. Temporary stream and wetland crossing options for forest management. General Technical Report NC-202. St. Paul, MN: U.S. Dept. of Agriculture, Forest Service, North Central Forest Experiment Station.

Board of Water and Soil Resources. Wetland Conservation Act Requirements- www.bwsr.state.mn.us/wetlands/regulation.html
www.bwsr.state.mn.us/wetlands/wca/forestryguidance.pdf.

Douglass, J.E.; Swank, W.T. 1975. Effects of management practices on water quality and quantity: Coweta Hydrologic Laboratory, North Carolina. In: Proceedings of the municipal watershed management symposium. Radnor, PA: U.S. Department of Agriculture, Forest Service, Northeastern Forest Experiment Station: 1-13.

Hansen, B. et. al., University of Minnesota. 2009. Cost Analysis of Alternative Culvert Installation Practices in Minnesota. Report number MN/RC 2009-20. Minnesota Department of Transportation, Research Services Section, St. Paul, Minnesota.
<http://www.lrrb.org/pdf/200920.pdf>.

Haynes, F. D., and K. L. Carey. 1996. Safe loads on ice sheets. U.S. Army Cold Regions Research and Engineering Laboratory, Ice Engineering Number 13. 4 p.

Minnesota Department of Natural Resources, Division of Forestry. 1989. Water Quality in Forest Management - Best Management Practices in Minnesota. 104 p

Minnesota Forest Resources Council. 2005 Forest Management Guidelines. http://www.frc.state.mn.us/documents/council/site-level/MFRC_FMG&Biomass_2007-12-17.pdf.

Minnesota Department of Natural Resources Manual: Best Practices for Meeting DNR General Waters Work Permit GP2004-0001.
http://files.dnr.state.mn.us/waters/watermgmt_section/pwpermits/DNR_GP_Guidance_Manual.pdf.

Minnesota Department of Natural Resources. Public Waters permits.
www.dnr.state.mn.us/permits/water/needpermit.html.

Minnesota Pollution Control Agency. Construction Stormwater Permit Requirements.
www.pca.state.mn.us/water/stormwater/stormwater-c.html,
www.pca.state.mn.us/publications/wq-strm2-15.pdf.

Minnesota Pollution Control Agency. Minnesota Stormwater Manual
<http://www.pca.state.mn.us/water/stormwater/stormwater-manual.html>

Mullis and Bowman, 1995. Use of wood waste for road construction in Southeast Alaska. In: Proceedings, 6th International conference on low-volume roads; 1995 June 25-26: Minneapolis, MN. Washington, DC: National Academy Press. 2:53-61.

Minnesota Department of Transportation, 2007. Temporary Stream and Soft Soil Crossings Workshop. After: Portland Cement Association, E I. DuPort literature; McCarthy, David F., "Essentials of Soil Mechanics and Foundations, " 1977; Tensar, 1998; Webster, Personal Communication 2001, "DCP vrs CBR Correlations", AASHTO, "1993 Guide for Design of Pavement Structures", Van Till et. al. NCHRP 128,
www.tensarcorp.com/uploadedFiles/SPECTRA_SOILSTRENGTH_3.03.pdf.

University of Minnesota Extension, 2002. Temporary Stream Crossings. Forest Management Practices Fact Sheet Crossing Options Series #1.
www.extension.umn.edu/distribution/naturalresources/DD7001.html.

University of Minnesota Extension. 2002. Forest Management Practices Fact Sheet Crossing Options Series #4.
www.extension.umn.edu/distribution/naturalresources/DD7004.html.

United States Department of Agriculture, Forest Services, Technology & Development Program. 1996. The Plastic Road.
www.fs.fed.us/eng/pubs/html/96241206/96241206.html.

USDA Forest Service, Technology and Development Program. 2008. Removing Slash Mats. Publication number 0851-2312-MTDC.
www.fs.fed.us/t-d/pubs/htmlpubs/hmt08512312/.

USGS, 2000. Soil Erosion from Two Small Construction Sites, Dane County, Wisconsin. USGS Fact Sheet FS-109-00.

<http://wi.water.usgs.gov/pubs/fs-109-00/fs-109-00.pdf>.

University of New Hampshire-Cooperative Extension, 2005. Best Management Practices for Forestry: Protecting New Hampshire's Water Quality. <http://extension.unh.edu/forestry/Docs/BMPBook.pdf>

Wiest, Richard L. 1998. A Landowner's Guide to Building Forest Access Roads. Technical Publication NA-06-98. Radnor, PA: U.S. Dept. of Agriculture, Forest Service, Northern Area State & Private Forestry.

Wisconsin Department of Natural Resources. 1995. Wisconsin's Forestry Best Management Practices for Water Quality. Publication number FR093, 76 p.

Wolf, Amy T. et. al. 2007. Impacts of Summer vs. Winter Logging on Understory Vegetation in the Chequamegon-Nicolet National Forest. Department of Natural and Applied Sciences, University of Wisconsin-Green Bay. Green Bay, WI.

<http://www.uwgb.edu/hower/FORECO10554.pdf>.

APPENDIX A: REGULATIONS

Several federal, state and local regulations exist that may affect work in and around wetlands, lakes and streams. These agencies regulate certain activities that affect the course, current, and cross-section of lakes, wetlands, rivers and streams. Some also regulate cultural resources and sensitive plants and animals that may be found on a site.

Federal

- Section 404 of the Clean Water Act and Section 10 of the Rivers and Harbors Act
- National Environmental Policy Act
- National Forest Management Act
- Coastal Zone Management Act
- Food, Agriculture, Conservation and Trade Act

State

- Minnesota Department of Natural Resources (MNDNR): Public Waters Work Permit Program
- Minnesota Pollution Control Agency- Construction Stormwater Permit and Clean Water Act (CWA) Section 401 Water Quality Certification
- Board of Water and Soil Resources (BWSR): Wetland Conservation Act

Local

Local units of government (County, City, Watershed): Wetland Conservation Act, local water plans and other local regulations

The following is more detailed information on regulations that may apply to your project:

U.S. Army Corp of Engineers

Most of the types of crossings described in this booklet require a permit from the Corps of Engineers under Section 404 of the Clean Water Act and/or Section 10 of the Rivers and Harbors Act. You are

advised to always contact the Corps before commencing any work in or near waters or wetlands.

U.S. Army Corps of Engineers, St. Paul District, Regulatory Branch: <http://www.mvp.usace.army.mil/regulatory/>. By telephone: 651-290-5375 or 800-290-5847, x5525.

Minnesota Department of Natural Resources

A MNDNR public waters work permit (application available under [DNR Division of Waters forms](#)) may be required for work in streams, lakeshores and public water wetlands.

Temporary Bridge

A permit is not required to build a temporary bridge across a stream if the following conditions are satisfied:

- The stream bank can support bridge without pilings, foundations, culverts, excavation, or other special site preparations.
- Nothing is placed in the bed of the stream.
- The bridge is capable of removal for maintenance and flood damage prevention.
- The bridge is firmly anchored at one end and can swing away during flooding.
- The lowest portion of the bridge is at least three feet above the ordinary high water level on navigable streams.
- The bridge construction is consistent with floodplain, shoreland, and wild and scenic river ordinances.

A fact sheet on temporary bridges and Fords is available on the MNDNR web site under information sheets and brochures at <http://www.dnr.state.mn.us/publications/waters/index.html>.

Fords

In Minnesota, a DNR permit is not needed for a Ford if it meets the following conditions.

- The streambed is capable of supporting the ford crossing without special site preparation.
- The water depth does not exceed 2 feet under normal summer flow conditions.
- The crossing conforms to the natural cross section of the stream channel and does not reduce or restrict normal low-water flows.
- The original streambank at the site does not exceed 4 ft in height.
- The crossing is constructed of gravel, natural rock, steel matting or other durable inorganic material not exceeding 1 foot in

thickness. Recycled asphalt to or construction rubble is not allowed.

- The approach is graded to a finished slope not steeper than 5 to 1 horizontal to vertical, and all graded banks are seeded and mulched to prevent erosion and sedimentation.
- The crossing is not placed on an officially designated trout stream; on a wild, scenic or recreational river; or on an officially designated canoe and boating route.

For more information on MNDNR permits, visit <http://www.dnr.state.mn.us/permits/water/needpermit.html> or contact the local area hydrologist.

Minnesota Pollution Control Agency (MPCA)

In general, if a Corps permit authorization is required, then an MPCA CWA Section 401 Water Quality Certification or waiver must also be obtained as part of the permitting process. The Section 401 Water Quality Certification ensures that the activity will comply with the state water quality standards. Any conditions required within the MPCA 401 Certification are then incorporated as conditions into the Corps 404 Permit. You can find additional information the MPCA's 401 Certification process at www.pca.state.mn.us/water/401.html.

Applicable Water Quality standards are in MN Rule 7050. These standards require the protection of wetlands from physical alteration by dredging, filling, draining, or permanent inundation and require the satisfaction of the wetland mitigation sequence (avoid, minimize, mitigate) to satisfy antidegradation requirements. MPCA also regulates the discharge of pollutants into water.

The National Pollutant Discharge Elimination System (NPDES) Construction Stormwater Permit is another area where MPCA may require a permit. There are exemptions for silvicultural activities. Specifically, construction of forest roads is exempt if constructed primarily for silvicultural activities with no intent for other uses such as residential access, hunting, and general recreation. Additional guidance is available on the MPCA fact sheets Construction Stormwater Permit - Forest Road Exemption (February 2009), <http://www.pca.state.mn.us/publications/wq-strm2-15.pdf>, and Construction Stormwater Permit Overview - A Technical **Summary**

of Minnesota's NPDES Permit (February 2009),
<http://www.pca.state.mn.us/publications/wq-strm2-05.pdf>

**Board of Water and Soil Resources (BWSR)
Wetland Conservation Act (WCA)**

Minnesota's Wetland Conservation Act falls under the Board of Water and Soil Resources rules. It regulates wetland draining and filling activities on all wetlands not covered by the Department of Natural Resource's Public Waters Work Permit Program.
<http://www.bwsr.state.mn.us/wetlands/regulation.html>.

WCA permitting authority is delegated to local governments. To find out who is the responsible local government in your project area, contact your local Soil and Water Conservation District office, listed in the Government Pages of the phone book.

Forestry Exemption- There is a forestry exemption for roads and skid trails specifically used for silviculture activity. The exemption does not apply to landing areas. They must be placed in upland areas. If an upland location is not possible, then the work may be done on frozen ground.

According to WCA, a replacement plan for wetlands is not required for, 1) temporary or permanent crossings, or for 2) entering a wetland to perform silvicultural activities, including timber harvesting as part of a forest management activity, so long as the activity:

- Limits the impact on the hydrologic and biologic characteristics of the wetland.
- Does not result in the construction of dikes, drainage ditches, tile lines or buildings.
- Does not result in the drainage of the wetland or public waters.
- Avoids filling whenever possible.

The primary use of the road must be for forest management activities, and the following must be followed:

- Use appropriate erosion control measures to prevent sedimentation.
- Does not block fish activity in a watercourse.
- Comply with all other applicable federal, state and

local requirements, including Best Management Practices and water resource protection requirements.

For more information, visit the following web site:

<http://www.bwsr.state.mn.us/wetlands/wca/forestryguidance.pdf>.

United States Department of Agriculture- Natural Resources Conservation Service

If your project is on agricultural land, the USDA NRCS gets involved. Contact your local Natural Resources Conservation Service office, listed under the United States government in the telephone directory, for more information. They are often in the same office as the local SWCD.

For information on cultural resources:

Office of the State Archaeologist
Fort Snelling History Center
St. Paul, MN 55111
(612) 725-2411 or (612) 725-2729
www.osa.admin.state.mn.us/

State Historic Preservation Office
Minnesota History Center
345 Kellogg Blvd. West
St. Paul, MN 55102
(651) 296-5434
email: mnshpo@mnhs.org
<http://www.mnhs.org/shpo/>